

RESOURCE CARD: MULTI SKILLS: YEAR 4

RELATES TO: WEEK 1

MAIN LESSON: DUCK, DUCK, GOOSE GAME

Make sure all pupils are spaced out accordingly.

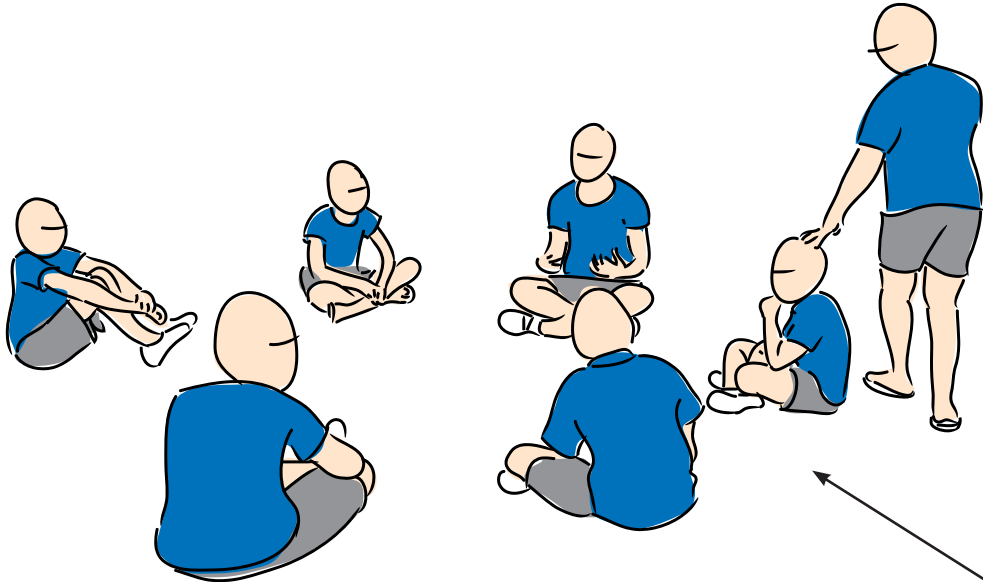

The fox goes around the group naming everyone a duck. When they choose to, they can call someone a goose.

When a pupil is named goose, they must chase the fox and try to catch them before they sit down in their original place.

RESOURCE CARD: **MULTI SKILLS:** YEAR 4

RELATES TO: **WEEK 1**

GAME / COMPETITION: **BEAN BAG RELAY RACE**

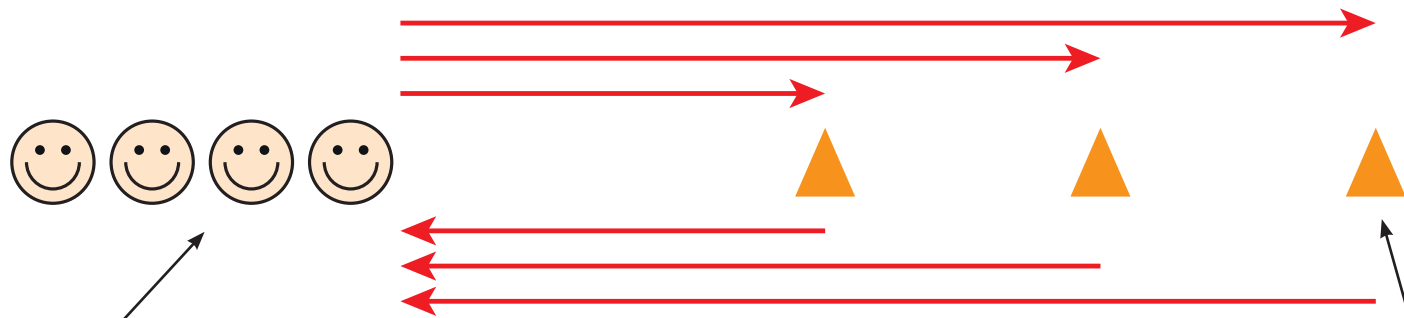

Pupils lined up one behind the other.

The first pupil runs up to the first cone, collects the bean bag and runs back, repeats to the second cone and then the third cone to do the same. The second pupil in line then runs to place the bean bag back on the cones.

Bean bags are placed on the cones for pupils to collect and return.

KEY



Player



Cone



Where the player moves to

RESOURCE CARD: MULTI SKILLS: YEAR 4

RELATES TO: WEEK 2

GAME / COMPETITION: BALL TAG

A few selected pupils are nominated to be the ball taggers at the edge of the area. They roll / throw the soft ball into the area to try and get others out.

Pupils start at one end of the playground and run to the opposite end. They must try to dodge the ball.

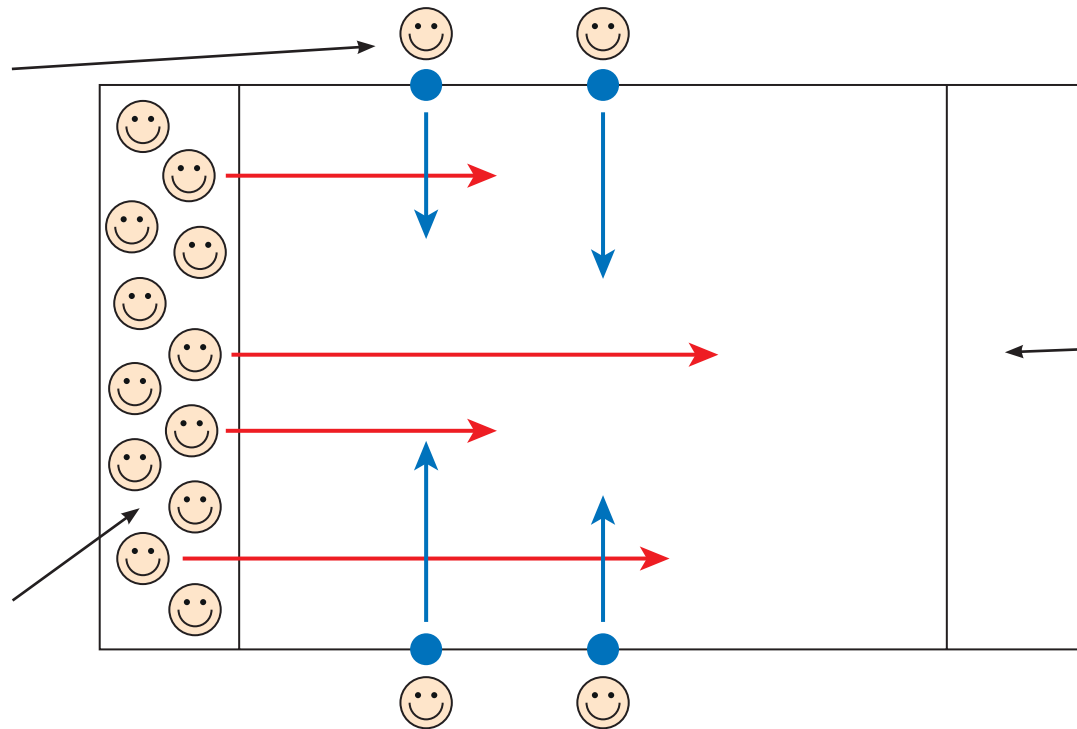

If pupils get to the opposite side without getting hit by the ball, they are safe.

KEY



Player



Ball



Where the player moves to



Where the ball moves to

RESOURCE CARD: **MULTI SKILLS:** YEAR 4

RELATES TO: **WEEK 3**

MAIN LESSON: **AGILITY LADDERS**

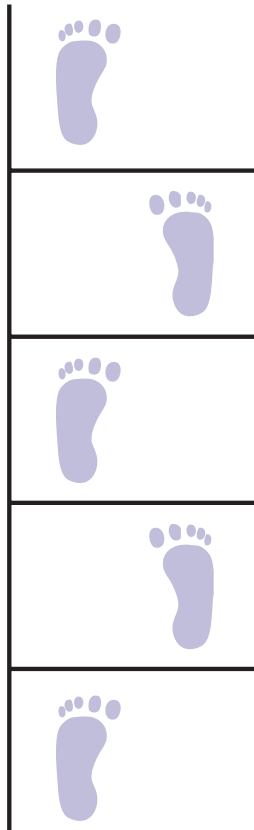

One foot in each space: Pupils are to lift their knees up and pump their arms forwards and backwards.

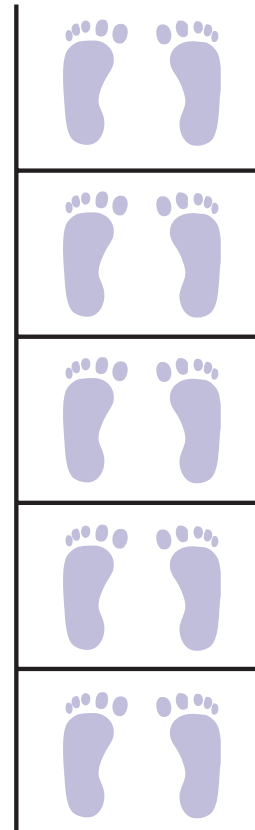

Pupils are to bunny hop into each of the spaces.

RESOURCE CARD: MULTI SKILLS: YEAR 4

RELATES TO: WEEK 4

MAIN LESSON: MOVE AND COLLECT

Pupils are to place one foot in each space before they collect the ball.

Pupils line up behind the ladder.

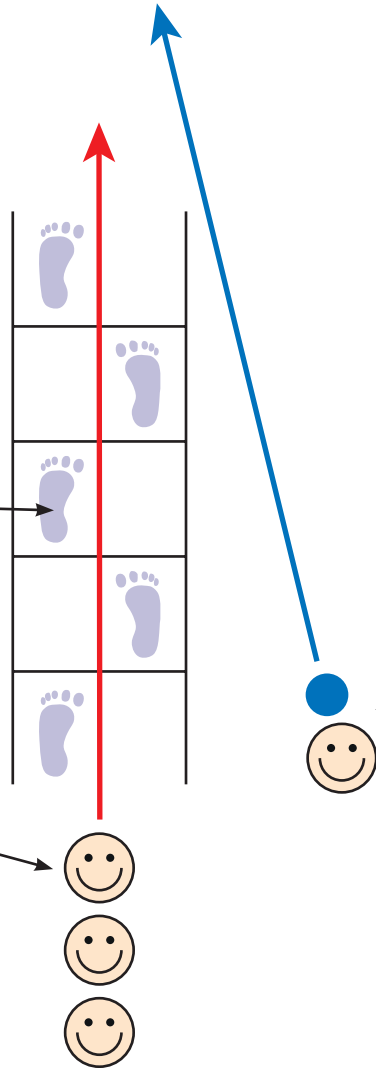

The feeder rolls the ball out for the pupils to collect after they have run through the ladder.

KEY



Player



Ball

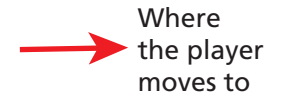

Where the player moves to

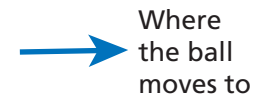

Where the ball moves to

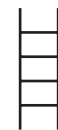

Agility ladder

RESOURCE CARD: MULTI SKILLS: YEAR 4

RELATES TO: WEEK 5



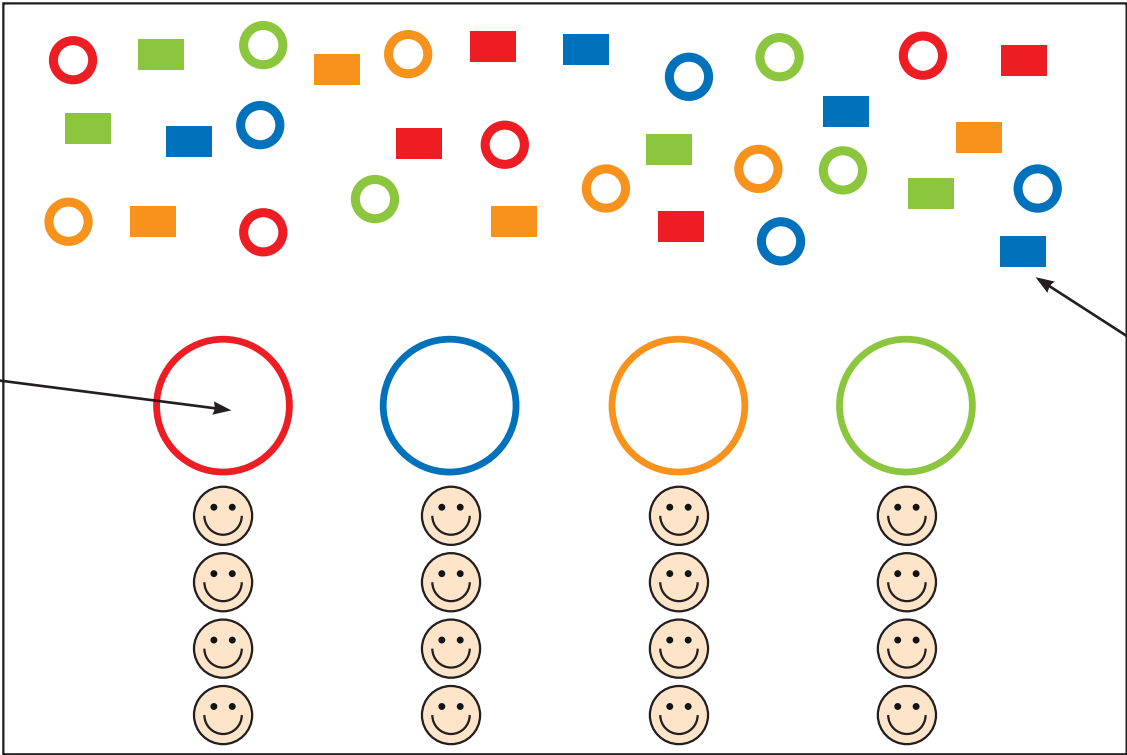

MAIN LESSON: DEVELOP



Pupils are to place the coloured objects into their designated hoop. The first group to collect all their objects are the winners.

Objects: Beanbags and Quoits to be collected from each group.

KEY

 Player	 Quoit	 Beanbag	 Hoop
--	---	---	---

RESOURCE CARD: **MULTI SKILLS:** YEAR 4

RELATES TO: **WEEK 6**

MAIN LESSON: OBSTACLE COURSE

Pupils are to:

- run through the ladder with one foot in each space
- side step in and out of the cones
- balance over the upside down bench
- and then throw the bean bag into the hoop

